

Section A-A

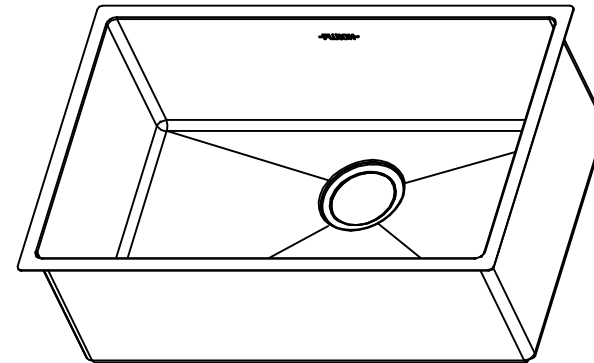
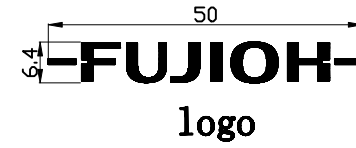

Draw		Material	SUS304	Name	Stainless Steel Sink		
Sales		Finish		PVD Color	No		
Check		Customer		Item No			
Approval				Customer Item	FZ-SN60-S63U		
				Time	20201014		
				Proportion	Page No	1-1	Edition: