

Section A-A

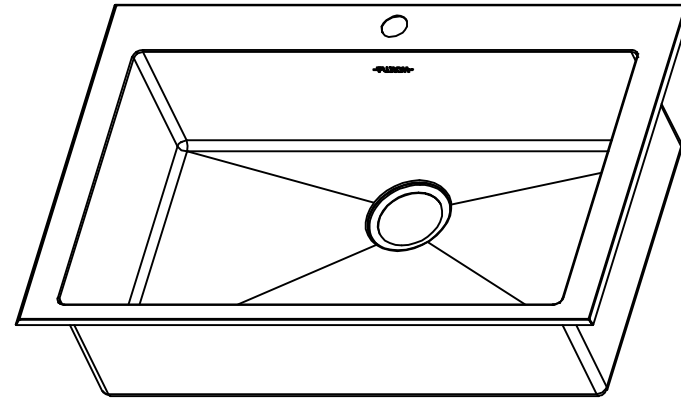
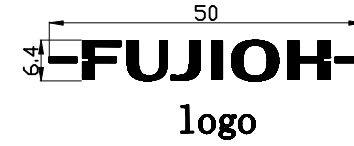

Draw		Material	SUS304	Name	Stainless Steel Sink		
Sales		Finish		Item No			
Check		Customer		Customer Item	FZ-SN50-S73T		
Approval				Time	20201014		
				Proportion		Page No	1-1 Edition: